

Confectionery Industry Conveyor Belts for Manufacturing Chocolates, Sweets, Candy and Bubble Gum

Habasit–Solutions in motion

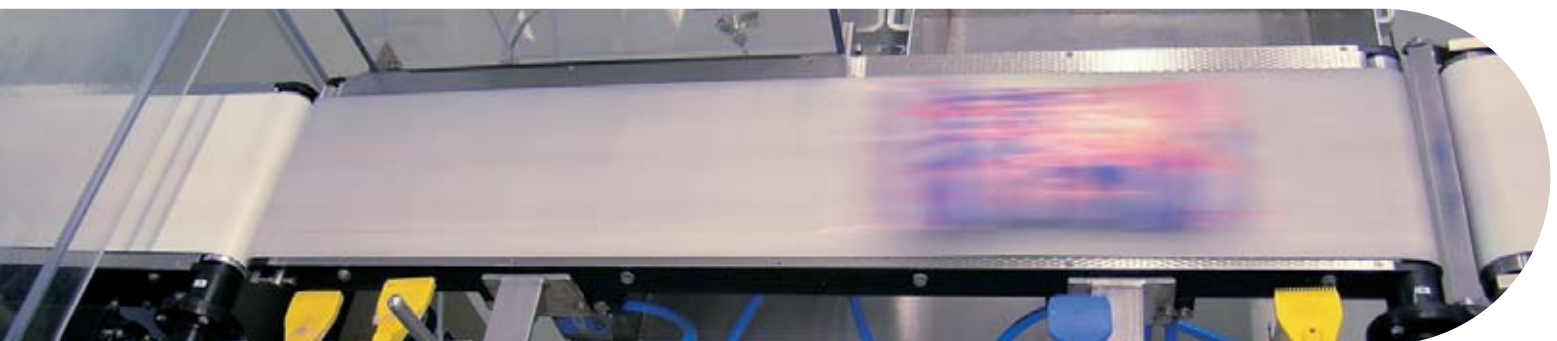

Introduction	3
Process / Application Overview (Schematic)	
• Chocolate Bar Manufacturing, Distribution / Feed-in, Wrapping and Packaging	4 – 5
• Moulded Chocolate Manufacturing	5
• Chewing Gum – Candy Processing	6 – 7
Variety of Product Ranges	8
Variety of Belt Surfaces / Styles	9
Confectionery Industry Application Table / Belt Selection Guide and Technical Key Data	10 – 11b
Features and Benefits	
• TPU Coated Belts	12
• TPO / Habilene® Coated Belts	13
• Plastic Modular Belts	14
Other Coating Materials	
• Silicone Coated Belts	15
• Antimicrobial TPU Belts	16
Successful Belt Solutions	17
Services	18
The Habasit Solution	19
Contacts	20

Product liability, application considerations

If the proper selection and application of Habasit products are NOT recommended by an authorized Habasit sales specialist, the selection and application of Habasit products, including the related area of product safety, are the responsibility of the customer. All indications / information are recommendations and believed to be reliable, but no representations, guarantees, or warranties of any kind are made as to their accuracy or suitability for particular applications. The data provided herein are based on laboratory work with small-scale test equipment, running at standard conditions, and do not necessarily match product performance in industrial use. New knowledge and experiences can lead to modifications and changes within a short time without prior notice. BECAUSE CONDITIONS OF USE ARE OUTSIDE OF HABASIT'S AND ITS AFFILIATED COMPANIES CONTROL, WE CANNOT ASSUME ANY LIABILITY CONCERNING THE SUITABILITY AND PROCESS ABILITY OF THE PRODUCTS MENTIONED HEREIN. THIS ALSO APPLIES TO PROCESS RESULTS / OUTPUT / MANUFACTURING GOODS AS WELL AS TO POSSIBLE DEFECTS, DAMAGES, CONSEQUENTIAL DAMAGES, AND FURTHER-REACHING CONSEQUENCES.

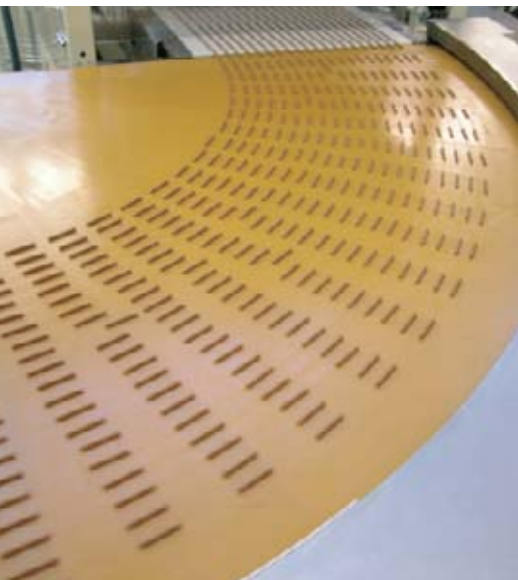

Focus on confectionery industry

The confectionery industry is divided into various segments, such as the production of chocolate, sweets, candy (e.g. jelly babies) and bubble gum. Habasit offers a complete range of conveyor belts for chocolate confectionery and candy processing.

Habasit products demonstrate excellent release properties even for very sticky goods, reliable positioning of products on the belt, high longitudinal flexibility to handle small pulley diameters, superior abrasion, chemical and oil resistance as well as easy-to-clean surfaces.

We offer solutions for cooling tunnels, power-turns, metal detecting, general conveying, packaging and check-weighing – in short for all related belting applications.

The variety of belts

Our range contains unique products like **Cleanline®**, coated with a modified TPO, especially developed to improve release of sticky food.

The new high grade Silicone belts and the **non-fray** and **frayless** TPU types offer special features for confectionery processes.

A specialty are the seamless **Grabber®** Vertical-form-Fill-Seal belts for reliable friction feed applications. Additional safety provide products as **HyGUARD®** and **HabaGUARD®** conveyor belts containing an antimicrobial additive.

Habasit's offer is completed by a broad range of **Plastic Modular Belts**, **HabaCHAIN®** plastic chains, **HabaSYNC®** timing belts, **Motors**, **Gearboxes** and many belting accessories.

More than 60 years of experience

With a comprehensive global sales and service network, Habasit is able to respond to any request that you may have with nothing less than an outstanding belting solution of highest quality, tailored to your specific needs.



Chocolate Bar Manufacturing, Distribution / Feed-in, Wrap

Chocolate bar manufacturing

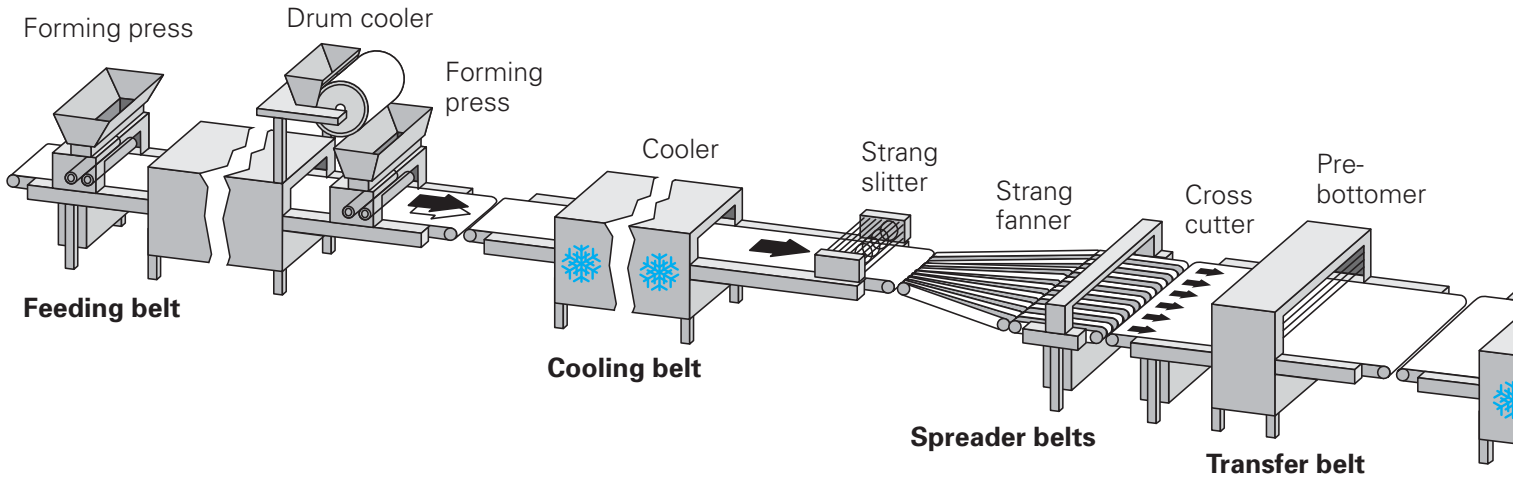

Distribution / feed-in, wrapping and packaging

Packaging unit and subsequent processes depending on kind of wrapping and packaging

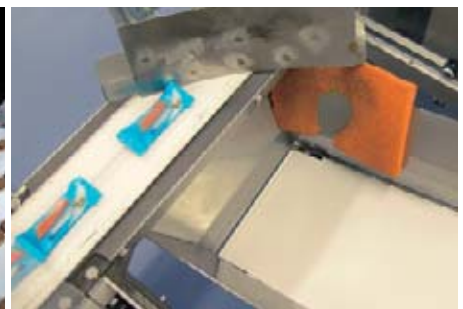
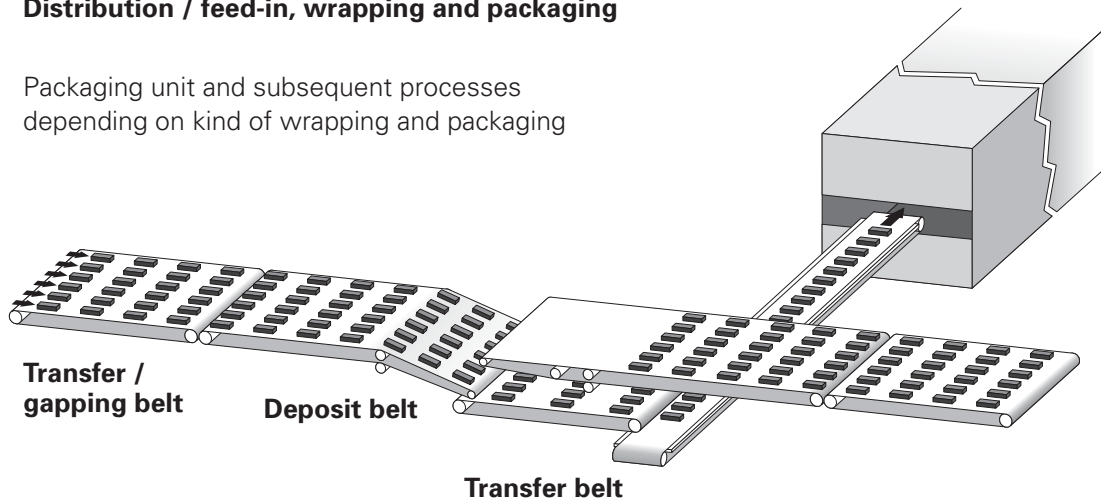

ping and Packaging

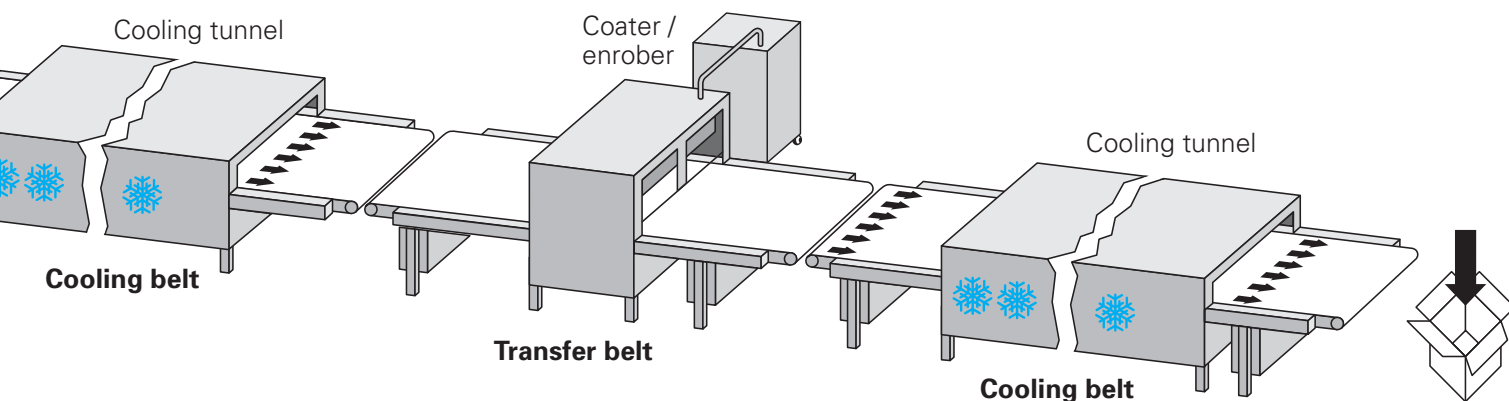

Moulded Chocolate Manufacturing

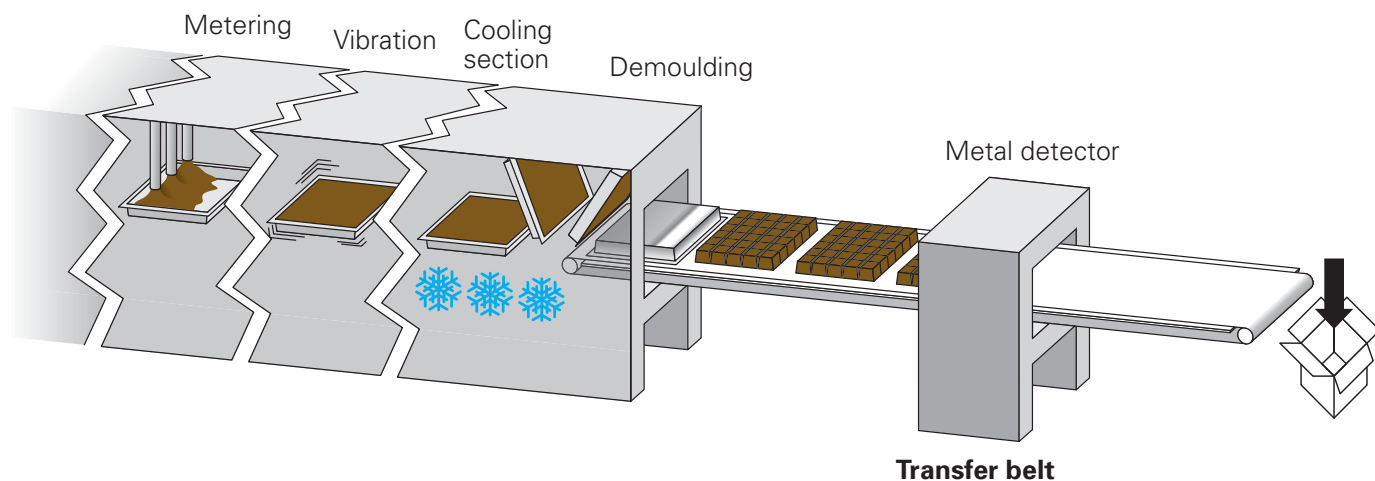

Process variant: Hollow / filled chocolate items

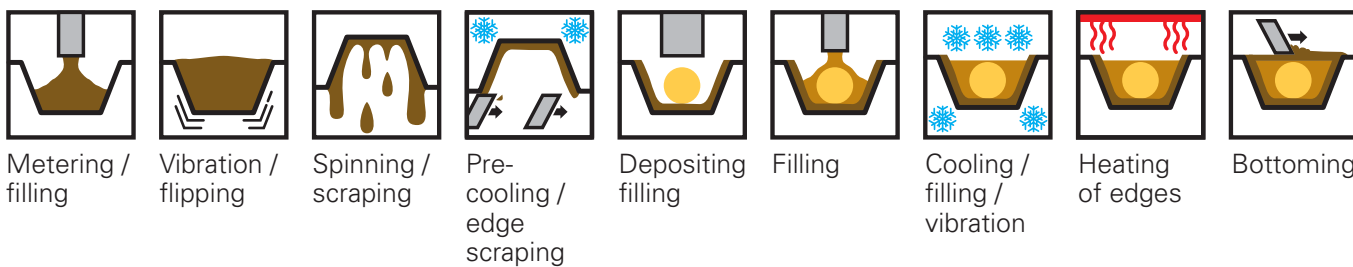

Process / Application Overview (Schematic)

Chewing Gum – Candy Processing

Chewing gum processing

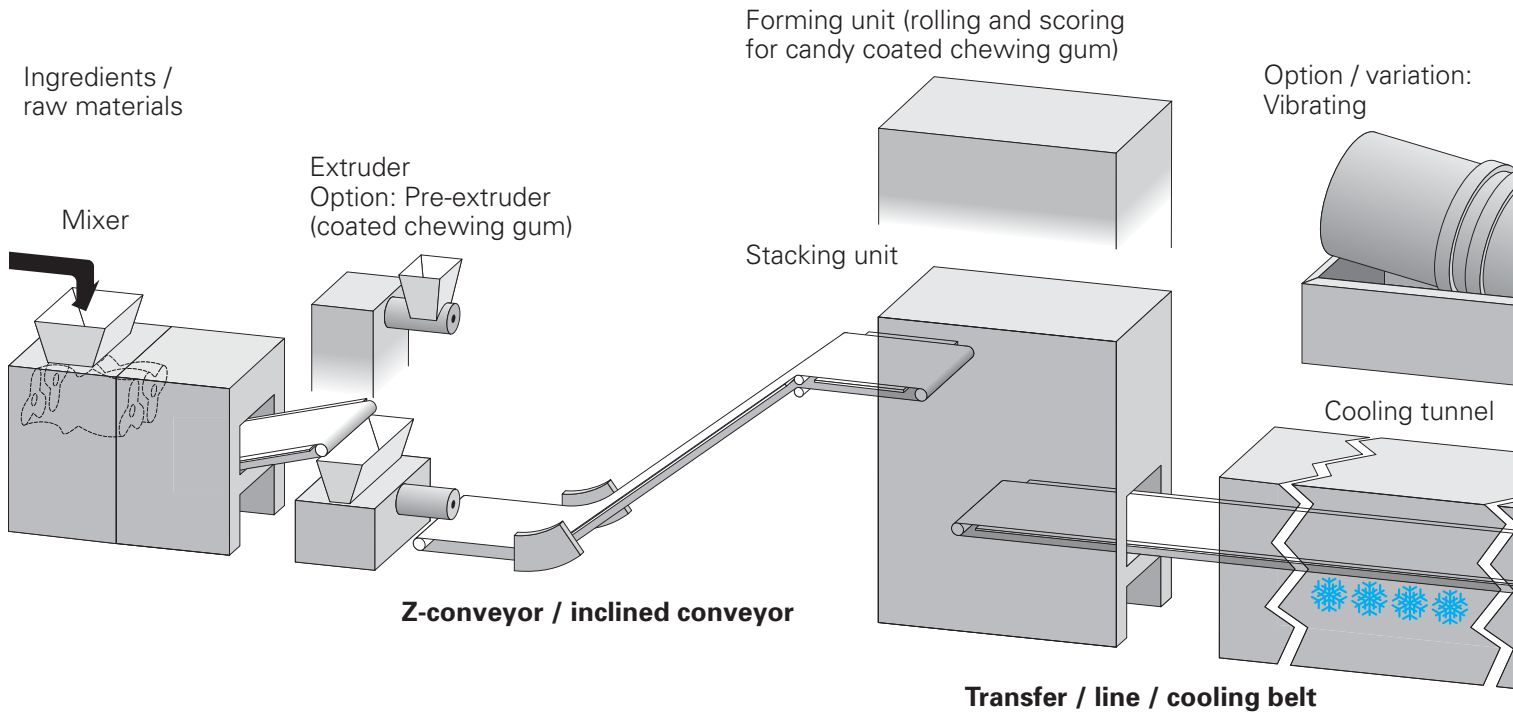

Candy processing (hard and soft)

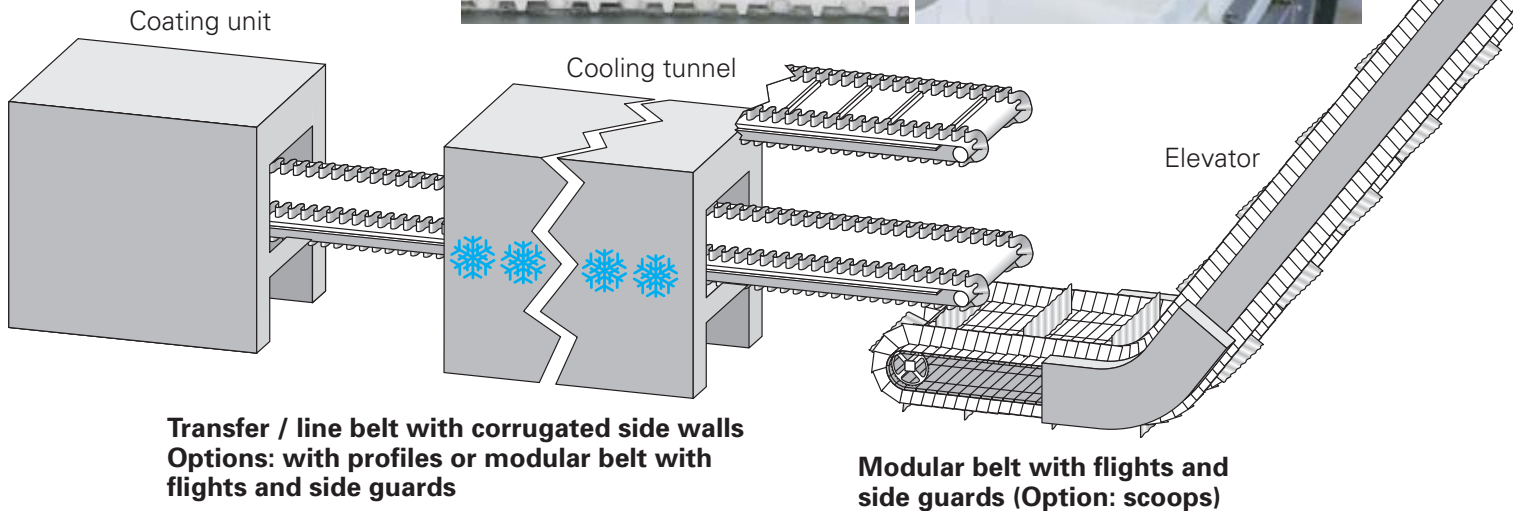

Tumbling drum

Coating pan

Polishing pan

Wrapping machine

Transfer / line belt with corrugated side walls
Options: with profiles or modular belt with flights and side guards

Packaging unit (Form - Fill - Seal unit)

Check-weigher unit

Transfer belt

Scaling belt

Grabber® Vertical-Form-Fill-Seal belts

Remark: The drawings are schematic examples of selected applications / processes. The drawings do not claim completeness. The belt recommendations (use / application / layout) are only general suggestions. Due to the complexity of various processes, technical requirements and decisive external influences (e.g. nature or property of transported goods, process speed, steps of treatment / handling, environment or process temperature, humidity, chemicals, additives, ingredients, recipes, etc.) there are many possible solutions.

The right choice

Habasisit has developed an extensive variety of solutions that allow customers to choose the best product for their specific application. Habasisit is the only belt supplier to manufacture and offer the full package of fabric based and plastic modular belts.

Belting products for the confectionery industry

Design / material variations

Fabric based conveyor belts



TPU coated belts

TPU coated frayless and non-fray belts

TPU coated customized embossed belts

TPO coated belts Cleanline®

Silicone coated belts

Antimicrobial belts

- HabaGUARD®
- HyGUARD®

Special products

Round belts

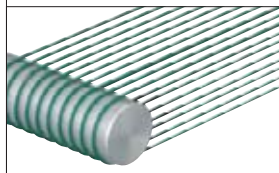

Polyurethane round belts

- Polycord®
- Habicord
- Habiblue

Rubber-coated seamless feeder belts



GRABBER® series

Plastic modular belts



PP (Polypropylene)

PE (Polyethylene)

POM/AC (Polyoxymethylene / Acetal)

PA (Polyamide)

Special materials

(e.g. high temperature materials, electrically conductive, detectable, submersible materials, etc.)



Please consult product brochure 4178 Plastic Modular Belts Product Guide or www.habasisitlink.com

Gear motors



For further information please consult www.rossimotoriduttori.it

Timing Belts

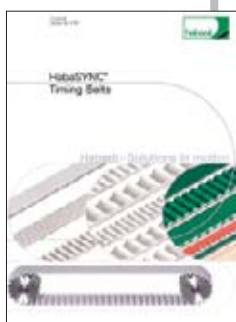

For details and further information please consult product brochure 4107 HabaSYNC®

HabaCHAIN®



Please consult product brochure 4122 HabaCHAIN®

Belt surface and function

To fulfill the requirements for a specific application or a defined process, the belt surface or the material inherent properties play a key role. Following a selection of various surfaces, styles and properties.

Illustrations: Product view from top (running direction from left to right).

Fabric based belts

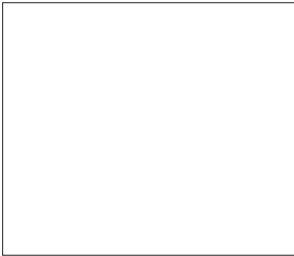

Blank smooth (adhesive, medium-adhesive or non-adhesive)

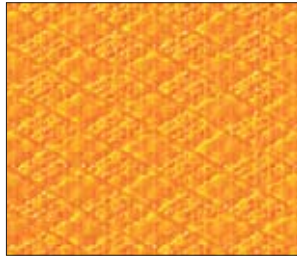

Diagonal rhomboid positive pattern / structure "Harlequin" (adhesive)

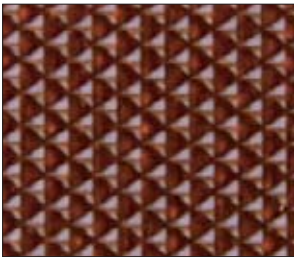

Diagonal rhomboid pattern / structure brown (adhesive)



Square embossing / structure (adhesive)



Customized embossing (adhesive)



Customized embossing (adhesive)



Customized embossing (adhesive)

Plastic modular belts



Flat Top 0.5"



Flush Grid 0.5"



Flush Grid 0.5"

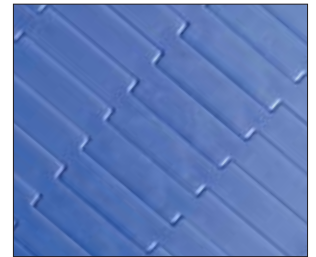

Micropitch 0.3"



Flat Top 1"



Flat Top 1"

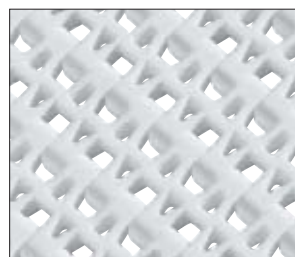

Flush Grid 1"

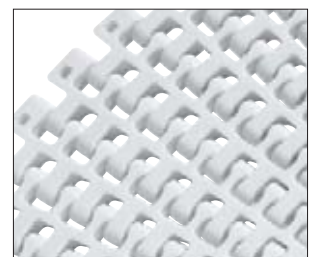

Radius Flush Grid 1"

Confectionery Industry Application Table / Belt Selection Guide and Technical Key Data (Selection only)

		Product Code							
		Conveyor belts and processing belts							
		TPU coated belts							
Application		FNB-2E	FNB-5E	FMB-2EIH	FMD-2EIH	FAB-3EB	T04 Amber Harlequin	F-3EXWT	T04 Brown Romboid
Chocolate bar processing									
Forming		•	•					•	
Precooling		•		•	•		•	•	•
Strand slicing and cutting			•					•	
Cross cutter			•					•	
Prebottomer		•	•	•	•			•	
Cooling tunnel		•		•	•		•	•	•
Enrobing		•	•	•	•			•	
Metal detection							•	•	•
General conveying		•	•				•	•	•
Power turn						•			
Check weighing		•	•					•	
Wrapping		•	•					•	
Chocolate and moulded chocolate processing									
Demoulding		•	•	•	•			•	
General conveying		•	•				•	•	•
Metal detection							•	•	•
Power turn						•			
Wrapping		•	•					•	
Check weighing		•	•					•	
Hollow chocolate body processing									
General conveying		•	•				•	•	•
Metal detection							•	•	•
Power turn						•			
Wrapping		•	•					•	
Check weighing		•	•					•	
Chewing gum processing									
Mixing			•					•	
Extruding		•	•					•	
Forming		•	•					•	
Cooling		•	•					•	
General conveying		•	•					•	
Wrapping		•	•					•	
Check weighing		•	•					•	
Candy processing (hard and soft)									
Coating			•					•	
Cooling		•	•					•	
Elevating									
Packaging		•	•					•	
Check weighing		•	•					•	
General conveying		•	•					•	
Product construction / design									
Conveying side (Material)		TPU	TPU	TPU	TPU	TPU	TPU	TPU	TPU
Conveying side (Surface)		Blk/smth	Blk/smth	Blk/smth	Dia rhom	Blk/smth	Harlequin	Blk/smth	Dia rhom
Conveying side (Property)		Non-adh	Non-adh	Med-adh	Med-adh	Med-adh	Non-adh	Med-adh	Non-adh
Conveying side (Color)		White	White	Honey	Honey	White	Honey	White	Brown
Technical key data									
Thickness	[mm]	0.6	1.3	0.6	0.65	0.8	0.7	1.1	0.9
	[in]	0.02	0.05	0.02	0.03	0.03	0.03	0.04	0.04
Pulley diameter minimum with counter flecion	[mm]	15	20	15	15	15	16	15	16
	[in]	0.6	0.8	0.6	0.6	0.6	0.6	0.6	0.6

Legend / remarks

See folding page (flap)

Remarks

All data are approximate values under standard climatic conditions: 23°C / 73°F, 50% relative humidity (DIN 50005/ISO 554), and are based on the Habasit Master Joining Method.

Legend

Blk/smth	=	Blank / smooth
Dia rhom	=	Diagonal rhomboid positive pattern / structure
Harlequin	=	Harlequin pattern / structure
Med-adh	=	Medium-adhesive
Non-adh	=	Non-adhesive
Squ-emb	=	Square embossing
Sup-adh	=	Super-adhesive
Text. struc.	=	Fine textile structure
TPO	=	Thermoplastic Polyolefine
TPU	=	Thermoplastic Polyurethane
•	=	applicable

Additional information regarding products, use, application descriptions, technical key data and engineering notes may be found at:

www.habasit.com or **www.habasitlink.com**

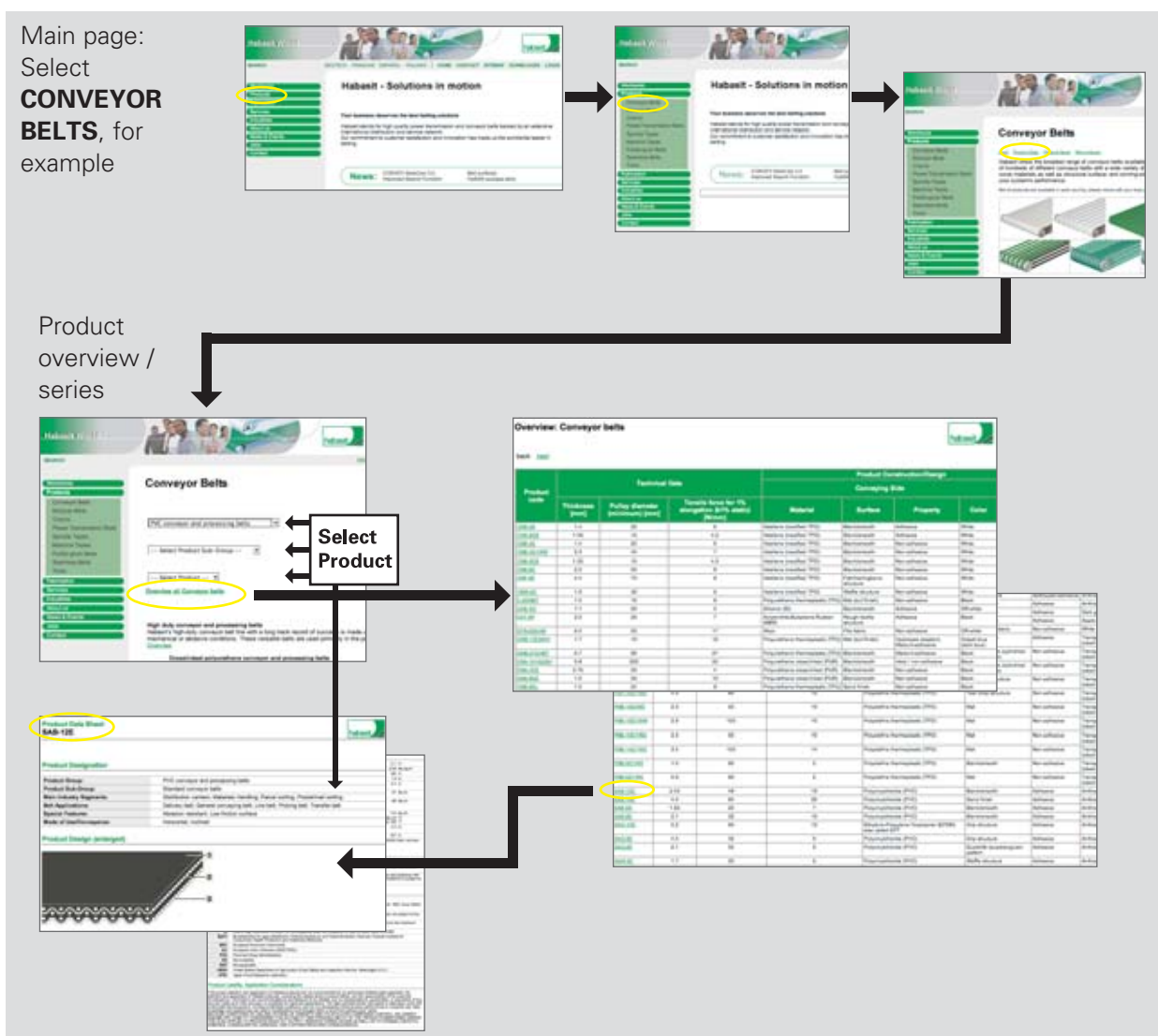



Features and Benefits

TPU Coated Belts

TPU food belts combine many outstanding features that are supporting reliable and hygienic production processes. TPU coated belts for high demanding applications, e.g. small pulleys and narrow transfers, wide temperature range, applications which ask for cut and abrasion resistant surfaces.

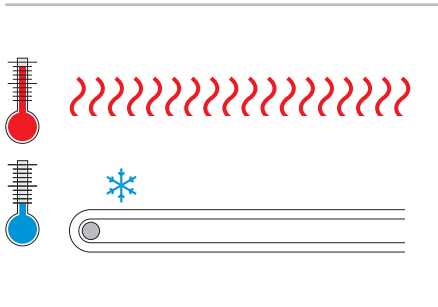
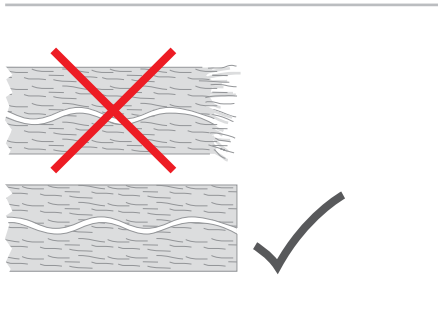

	Features	Benefits
	<ul style="list-style-type: none"> • Longitudinal flexibility 	<ul style="list-style-type: none"> → Belts can cope with small pulley diameters, compact design → Smooth and trouble-free product transfer → Low energy consumption
	<ul style="list-style-type: none"> • Calendered TPU belt surface 	<ul style="list-style-type: none"> → Closed, most homogeneous surface → Reduced soiling of belt surface → Good release properties → Easy to clean → Increased hygiene
	<ul style="list-style-type: none"> • Oil and fat resistance • Very good chemical resistance 	<ul style="list-style-type: none"> → No surface changes and damages → Reliable / constant conveying → Long belt life
	<ul style="list-style-type: none"> • Good temperature resistance 	<ul style="list-style-type: none"> → High temperature suitable up to 100°C / 212°F → Use in low temperature environment and warm conditions without changing its features → Process reliability
	<ul style="list-style-type: none"> • Superior edge fray resistance • "Frayless and Non-fray" belts 	<ul style="list-style-type: none"> → Less stringing or fraying of belt fabrics → Reduced risk of product contamination → Extended belt service life

Features and Benefits

TPO / Habilene® Coated Belts

Habilene® coating is a high-tech food thermoplastic polyolefin specially modified by Habasit. Habilene® is a sophisticated belt coating for easy release of sticky goods and excellent chemical resistance. Habilene® coated belts are called Cleanline®, a name linked with a clean belt environment, hygienic conveying, efficiency and reliability.



	Features	Benefits
	<ul style="list-style-type: none"> • Absolutely blank, smooth, closed and non-porous belt surface • Calendered surface coating 	<ul style="list-style-type: none"> → Reduced soiling of belt surface → Outstanding release properties → Easy and efficient cleaning – cost/time savings → HACCP support (HACCP = Hazard Analysis and Critical Control Points)
	<ul style="list-style-type: none"> • Excellent release properties • Low surface energy • Non-polar material 	<ul style="list-style-type: none"> → Excellent release of sticky products → Less soiling → Minimum affinity of surface with food, food-residues and bacteria → Efficient and reliable processing → Reduced waste and downtime → Easy to clean → Less biofilm formation
<p>FDA USDA EU conformance</p>	<ul style="list-style-type: none"> • Excellent chemical resistance • Suitable for high-frequency applications • Microwave suitable 	<ul style="list-style-type: none"> → Resistant to acids, alkaline, alcohol, oil, fat, chlorine, detergents, hot water, salt, UV-radiation → Resistant to aggressive cleaning agents → No damage of belt surface due to chemicals → No layer delamination → Save and reliable processing
	<ul style="list-style-type: none"> • Excellent low temperature resistance down to -40°C / -40°F 	<ul style="list-style-type: none"> → Suitable for cooling lines and cold stores → No loss of bending properties in low temperature environment → No cracking of belt surface
	<ul style="list-style-type: none"> • Environment-friendly product • Improved ecological profile 	<ul style="list-style-type: none"> → Cleanline® belts are easily disposable → Only water H₂O and carbon dioxide CO₂ are set free when burnt → Lower belt disposal costs

Features and Benefits

Plastic Modular Belts

Based on our comprehensive experience and our leadership position in traditional fabric-based belting, Habasit has developed the HabasitLINK® / KVP® modular belt range. This state-of-the-art product line completes our offer as a single source supplier and partner for your success. Plastic modular belts are used successfully in a wide range of industries like meat, poultry, fish, bakery, fruits, vegetables, snacks, beverage, bottling, and many more.

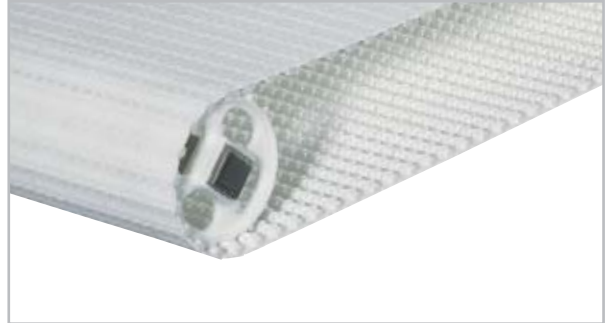

	Features	Benefits
	<ul style="list-style-type: none"> • Very small transfer due to improved modular belt design 	<ul style="list-style-type: none"> → Smooth transfer between conveyors (radius = 8 mm / 0.31 in.) → Efficient and safe product handling → Micropitch (radius = 6 mm / 0.236 in.)
	<ul style="list-style-type: none"> • Radius and straight transport with one single belt 	<ul style="list-style-type: none"> → Larger runs without transfers → Smaller number of drives and motors → Reduced cost for entire system
<p> PP = Polypropylene PE = Polyethylene POM/AC = Polyoxymethylene / Acetal PA = Polyamide </p>	<ul style="list-style-type: none"> • Large variety of plastic materials and colors available 	<ul style="list-style-type: none"> → Optimum adaptation to needs of an application → Tailor-made solutions → The best solution for most applications → High lateral stiffness design
	<ul style="list-style-type: none"> • Positive drive and tracking by belt engaged with sprockets • Guided belt alignment 	<ul style="list-style-type: none"> → Straight running, even under influence of transversal forces → Exact positioning of goods → No need for tensioning devices → No re-adjustments, no downtimes → Reliable tracking → Elimination of belt edge damages → Simple system design
	<ul style="list-style-type: none"> • Easy installation • Simple and fast assembling 	<ul style="list-style-type: none"> → Snap-in assembling method → Replacement of single belt modules → Easy repair

High grade Silicone coating

New high duty food grade Silicone coating for demanding applications.

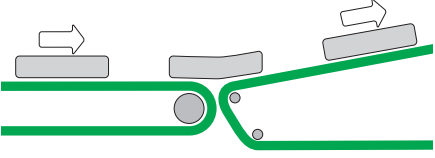
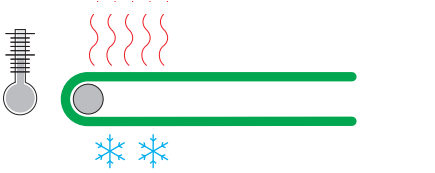
	Features	Benefits
	<ul style="list-style-type: none"> • Vulcanized coating 	<ul style="list-style-type: none"> → Excellent abrasion resistance → Extended belt life → Smooth and textile structured surfaces → Super adhesive surface for steep incline / decline
	<ul style="list-style-type: none"> • Easy release properties 	<ul style="list-style-type: none"> → Reliable transfer of sticky goods → Waste reduction → Hygiene support
	<ul style="list-style-type: none"> • Elevated temperature resistance 	<ul style="list-style-type: none"> → Temperature resistance up to 150°C or 180°C depending on belt construction → Extended belt life → Wider area of application

Antimicrobial TPU belts

HabaGUARD® and HyGUARD® antimicrobial belts contain an antimicrobial additive as an additional hurdle to prevent the growth of microorganisms.

The use of antimicrobial food conveyor and processing belts is an important and precautionary step in the prevention of microbial growth. Adhering to proper cleaning procedures is always essential.

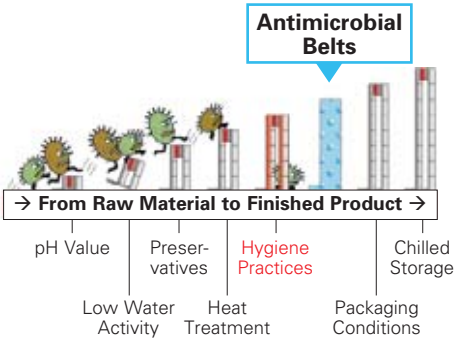
	Features	Benefits
 <p>→ From Raw Material to Finished Product →</p> <p>pH Value Preservatives Hygiene Practices Chilled Storage</p> <p>Low Water Activity Heat Treatment Packaging Conditions</p>	<ul style="list-style-type: none"> • Hurdle against microorganisms • Additive is registered with the EPA* and in compliance with FDA, USDA and EU regulations (EU HyGUARD® only) 	<ul style="list-style-type: none"> → Broad efficacy against microorganisms → Prevention of growth of moulds → Delay formation of biofilms → Additional hurdle against contamination by microorganisms → Additive remains effective after repeated cleanings and normal wear throughout the operating life of the belt <p>* EPA = Environmental Protection Agency (US authority) for food contact applications</p>

Added customer value

Each of our employees is a specialist who is at your service to provide you with belting solutions that will best suit your needs. Some examples of currently successful applications which are giving added value to the customer are listed below:

	Application	Forming of chocolate bars (strand slicing and cutting)
	Challenge	<ul style="list-style-type: none"> • Cutting strands of raw dough on belt surface leads to reduced life time of belt • Dough sticks to belt surface and leads to soiling / product losses
	Solution and result	Installation of Cleanline® or TPU coated belts <ul style="list-style-type: none"> • Excellent release (Cleanline®), perfect product flow • Outstanding abrasion resistance (TPU coatings), increased service life
	Application	Cooling tunnel application
	Challenge	<ul style="list-style-type: none"> • Temperature transition • Unstable product positioning • Irregular embossing of products or irregular belt imprint on chocolate
	Solution and result	Installation of Habasit TPU coated cooling belts <ul style="list-style-type: none"> • Reliable temperature transition • Constant positioning and precise product flow • Homogeneous belt impression / perfect embossing impression • Customized embossing / solutions available
	Application	Enrobing
	Challenge	<ul style="list-style-type: none"> • Critical take-over of coated and sticky products • Sticking of product parts to the belt • Damaging and soiling of products, manufacturing interruptions
	Solution and result	Installation of TPU or Habilene® coated Cleanline® belts <ul style="list-style-type: none"> • Excellent release of the sticky goods (Cleanline®) • No damages / breakdowns • Constant / reliable take-over respectively flow of products
	Application	Inclination / elevating of candy
	Challenge	<ul style="list-style-type: none"> • Inclined transport of small products • Regular fall-off (product loss) at edges
	Solution and result	Installation of HabasitLINK® plastic modular belts with flights and sideguards <ul style="list-style-type: none"> • Strong incline angle with high sideguard avoids loss of products • Reduced space, compact machine design
	Application	Packaging / feeding of wrapping machines
	Challenge	<ul style="list-style-type: none"> • Product positioning not precise, rather accidentally • Linking process interruptions, acceleration inconsistent
	Solution and result	Installation of TPU, Silicone or seamless belts (GRABBER®) <ul style="list-style-type: none"> • Excellent tracking, consistent position • Precise towing effect, constant wrapping / flow • Reduced belt abrasion (GRABBER®)
	Application	Power turn applications
	Challenge	<ul style="list-style-type: none"> • Flexibility of belts in all directions • Tracking and product positioning • Ability to equip different power turn systems
	Solution and result	Installing of TPU or Habilene® coated Cleanline® products <ul style="list-style-type: none"> • Fabric belts for curves or 45° transfer • Nosebar suitable belts for tight, smooth transfer of products • HabasitLINK® modular radius belts for packaging applications

Comprehensive services are central to Habasit’s solution approach. As committed partners to our customers, we are dedicated to sharing our knowledge and to providing full support.



Consulting and technical support

Habasit offers the best consulting and technical support on the belting market. Everything revolves around our customers. Each affiliate has its own belting experts. The Habasit team proudly provides the highest levels of support and top-quality products enjoyed by the global market for over 60 years.

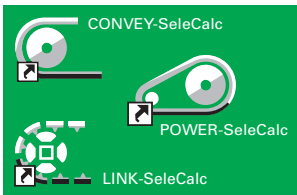

Assistance with belt selection and calculation

We will select and calculate the most suitable belt for your specific application. You may also do this yourself with our state-of-the-art Habasit selection and calculation program “SeleCalc”. To order this program free of charge, simply call your nearest Habasit partner or contact: info@habasit.com.



Fabrication, assembly and local installation services for quick reaction times

We make belts endless or assemble modular belts or chains, either at our own locations or on-site directly on your machine or system. Habasit operates more than 30 affiliated companies worldwide, each with its own inventory, fabrication, assembly and service facilities. Together with our representative offices and numerous qualified distributors, we can react quickly, competently and reliably to satisfy all your demands.



Tools, fabrication tools and auxiliaries

Offering superior fabrication capabilities is a key element in Habasit’s service concept. The joining can be done either by the customer or by Habasit’s on-site service. These two approaches are based on two different principles. Habasit provides solutions for both: a well-adapted range of joining tools / systems and an extensive service network.



Customer training programs

Habasit offers training programs and support tools to ensure optimal use of our products and to prolong their life cycles. Training on fabrication, installation, assembly, maintenance and belt repair takes place at Habasit sites or at your location.



Belt monitoring, inspections, analyses and process optimization proposals

We organize and handle belt maintenance, inspections, analyses and surveys for your locations. On request we will also work with you to develop optimization proposals, e.g. to achieve added value from the machinery or process output.



Design assistance for customized solutions

Habasit believes in partnership. Our engineering team will work closely with your engineers on joint design developments, preferably from a very early stage. We particularly recommend this for projects involving new technologies or large-scale modifications and adaptations.

At Habasit, we listen to our customers, innovate continuously and deliver reliable solutions to meet your every need.

Customers come first

At Habasit we understand that our success depends on your success. This is why we offer solutions, not just products; partnership, not just sales. Since our foundation in 1946, Habasit has brought this understanding of customer needs to life every day and for every application. That's why we're the No. 1 in belting today. Worldwide.



Committed to innovation

Habasit is strongly committed to the continuous development of innovative, value-added solutions. Over 3% of our staff are dedicated exclusively to R&D, and our annual investment in this area exceeds 8% of turnover.



Certified for quality

We deliver the highest quality standards not only in our products and solutions, but also in our employees' daily work processes. Habasit AG is certified according to ISO 9001:2000.



Worldwide leading product range

Habasit offers the largest selection of belting, conveying, processing and complementary products in the industry. Our response to any request is nothing less than a specific, tailor-made solution.

A selection of our product ranges:



HabaFLOW®
Fabric based conveyor and processing belts



HabasitLINK® & KVP®
Plastic modular belts



HabaDRIVE®
Power transmission belts



HabaSYNC®
Timing belts



HabaCHAIN®
Chains (slat and conveyor chains)



HabiPLAST®
Profiles
Guides
Wear strips



Machine tapes



Seamless belts

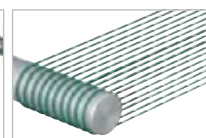

Round belts



Fabrication tools (joining tools)



Gear reducers
Gearmotors
Motion control



Electric motors

Worldwide support

Our extensive organization is ready to support you anywhere in the world. Engineering and emergency assistance, quotes and order status are just a phone call away. Wherever you are. Whenever you need us.

For additional information please visit:
www.habasit.com

Austria

Habasit GmbH, Wien
Phone: +43 1 690 66
www.habasit.at

Belgium

Habasit Belgium N.V., Zaventem
Phone: +32 2 725 04 30
www.habasit.be

Canada

Habasit Canada Ltd., Oakville
Phone: +1 905 827 4131
www.habasit.ca

China

Habasit East Asia Ltd., Hong Kong
Phone: +852 2145 01 50
www.habasit.com.hk

Habasit (Shanghai) Co., Ltd.
Shanghai

Phone: +8621 5488 1228
Phone: +8621 5488 1218
www.habasit.com.hk

Czech Republic

Habasit Bohemia spol. s.r.o., Brno
Phone: +4205 41 421 651
www.habasit.cz

France

Habasit France S.A.S., Mulhouse
Phone: +33 389 33 89 03
www.habasit.fr

Germany

Habasit Rossi GmbH,
Eppertshausen
Phone: +49 6071 969 0
www.habasitrossi.de

Hungary

Habasit Hungária Kft., Esztergom
Phone: +36 33 510 610
www.habasit.hu

India

Habasit-lakoka Pvt. Ltd., Coimbatore
Phone: +91 422 262 78 79
www.habasitlakoka.com

Italy

Habasit Italiana SpA
Customer Care:
Phone: 199 199 333
For int. calls: +39 0438 911444
www.habasit.it

Japan

Habasit Nippon Co. Ltd., Yokohama
Phone: +81 45 476 03 71
www.habasit.co.jp

Latvia

Habasit Baltic SIA, Daugavpils
Phone: +371 54 074 88
www.habasit.lv

Netherlands

Habasit Netherlands BV, Nijkerk
Phone: +31 33 24 72 030
www.habasit.nl

New Zealand

Habasit Australasia Ltd., Hornby
Phone: +64 3348 5600
www.habasit.co.nz

Norway

Habasit Norge A/S, Oslo
Phone: +47 81 55 84 58
www.habasit.no

Poland

Habasit Polska Sp. zo.o.,
Dąbrowa Górnicza,
Phone: +48 32 639 02 40
www.habasit.pl

Romania

Habasit Import/Export Romania SRL,
Bucuresti, Phone: +40 21 323 95 65
www.habasit.ro

Russia

OOO Habasit Ltd., St. Petersburg
Phone: +7 812 365 64 62
www.habasit.ru

Singapore

Habasit Far East Pte. Ltd., Singapore
Phone: +65 6862 55 66
www.habasit.com.sg

Spain

Habasit Hispanica S.A.,
Barberà del Vallès
Phone: +34 93 719 19 12
www.habasit.es

Sweden

Habasit AB, Hindas
Phone: +46 301 226 00
www.habasit.se

Switzerland

Habasit Schweiz, Reinach
Phone: +41 61 715 15 75
www.habasit.ch

Taiwan

Habasit Rossi (Taiwan) Ltd.
Taipei Hsien
Phone: +886 2 2267 0538
www.habasit.com.tw

Turkey

Habasit Kayis San. Ve Tic. Ltd. Sti.
Yenibosna - Bahcelievler - Istanbul
Phone: +90-212-654 94 04
www.habasit.it

Ukraine

Habasit Ukraina, Vinnica
Phone: +38 0432 58 47 35
www.habasit.ua

United Kingdom and Ireland

Habasit Rossi (UK) Ltd., Silsden
Phone: +44 870 835 9555
www.habasitrossi.co.uk

USA

Habasit America
Suwanee, Georgia
Phone: +1 800-458-6431
www.habasitamerica.com

Habasit America (Habasit ABT)
Seamless Belts
Middletown, Connecticut
Phone: +1 860 632 2211
www.seamlessbelts.com

ROSSI GEARMOTORS

a partner of Habasit, is one of Europe's largest industry groups for the production and sale of gear reducers, gearmotors, inverters, standard and brakemotors.

Rossi Motoriduttori

Via Emilia Ovest 915/A
41100 Modena - Italy
Phone: +39 059 33 02 88
www.rossi-group.com
info@rossi-group.com

Headquarters

Habasit AG
Römerstrasse 1
CH-4153 Reinach, Switzerland
Phone +41 61 715 15 15
Fax +41 61 715 15 55
E-mail info@habasit.com
www.habasit.com

Registered trademarks
Copyright Habasit AG
Subject to alterations
Printed in Switzerland
Publication data:
2039BRO.FOD-en0208HQR